



**NEW & IMPROVED FEATURES**

Including Skypod Acute & SQ

# skypod<sup>®</sup>

Eye-catching, affordable and easy to install  
pitched PVC-U lantern roofs

**eurocell<sup>®</sup>**  
All together better



skypod®

## PITCHED PVC-U LANTERN ROOFS

There are lots of ways to add light to buildings, but none are as stylish as Skypod pitched PVC-U lantern roofs

### **Impress customers and end-users with desirable, space-enhancing lantern roofs**

The Eurocell Skypod pitched lantern roof system enables you to create an eye-catching, contemporary feature that floods the interior of a property with natural light. It brings life and freshness to uninspiring flat-roofed buildings, and makes a stunning alternative to conventional conservatory roofs.

Skypod lantern roofs add height, light and volume to any living space. They are the perfect choice for a wide range of refurbishment, extension or new-build projects – including reception areas, classrooms, orangeries, kitchen-diners and garage conversions.

### **Affordable, energy efficient and attractive – the perfect alternative to aluminium**

Eurocell designed Skypod as an affordable alternative to aluminium skylights, making it accessible for more applications, to more people. As well as value issues, the 'industrial' aesthetic of aluminium skylights is unsuited to many properties and not to everyone's taste.

Skypod offers significant energy-efficiency improvements, with a U-value as low as 1.0\* – helping your customers to save on their energy bills. The PVC-U cappings also help homeowners to match the appearance of their lantern roof to existing PVC-U windows and doors.

## WHY CHOOSE SKYPOD?



**Designed for superior performance**



**Fast, accurate installation**



**U-values as low as 1.0\***



**20° or 35° fixed pitch**



**A choice of frame and glass colours**



**Cheaper than aluminium alternatives**



**Kits delivered in 4 working days<sup>†</sup>**



**10-year guarantee**

The architectural design means there are no fussy crestings or finials to fit, giving your customers the ultimate in clean sight-lines. A unique ridge end cover cap completes the sleek appearance.

### **Create lantern roofs of any size, up to 2.75m × 8.7m**

Skypod is available in a wide range of sizes, so you can create a lantern roof that's suitable for any project. With ten design options to choose from – including Skypod SQ and Skypod Acute – you can tailor Skypod to suit your customers' individual needs.

### **Simple, fast installation – for a quality-assured finish on every job**

Crucially, Skypod has been designed for fast, accurate, simple installation. It requires only square cuts, with no mitring or awkward angles to negotiate, and all screw holes are pre-drilled. This enables installers to give

customers a precision-fitted watertight lantern roof, while making the job as quick and easy as possible.

### **Delivered in four working days**

Once the site has been surveyed and measurements taken, you can order your bespoke Skypod roof from any of the 195+ Eurocell branches across the UK. Your complete ready-to-install kit, including all screws and fixings, will be delivered to the branch in 4 working days<sup>†</sup>. You can then either collect it yourself or arrange free delivery direct to your site<sup>\*\*</sup>.

### **Complete the job**

All the tools and sealants you need to install your lantern roof to the highest standard are available from your local Eurocell branch, so you can pick up everything you need when you collect your Skypod. It's important to use a sealant that is compatible with self-cleaning glass, and we recommend Soudal SMX 506.

\* Standard U-value is 1.2. U-value is applicable to glass only.

\*\* Free delivery applies to orders over £50 and deliveries to mainland UK only, excluding Northern Scotland.

<sup>†</sup> 5 days for branch customers.





## MORE FLEXIBILITY

TEN LANTERN ROOF STYLES ARE NOW AVAILABLE

### No side rafter bars

With the fewest possible number of slimline bars needed to create uninterrupted glazed surfaces of up to 1.5m x 2.75m, Skypod with no side rafter bars is the cleanest, simplest way to introduce overhead natural light into any room space. It offers a practically unobstructed window on the world above and, come rain or shine, keeps homeowners warm and comfortable thanks to its temperature controlling glass and high levels of energy efficiency.

### With side rafter bars

By introducing additional bars to the standard Skypod design, side rafter bars extend the possibilities for fully glazed rooflights to spans of up to 1.5m wide x 7.45m long. The result is a dazzling feature roof that turns what could so easily be an underwhelming flat roof extension into a year round living space with all the natural light and lofted headroom your customers could ever wish for.



Skypod with no side rafter bars



## Three-bar gable

The extra strength and rigidity of our 3-bar Skypod option not only allows you to install even longer, even wider vaulted rooflights into your customers' homes. It also gives a much more traditional 'orangery' style look to their rooflight, with the introduction of classically proportioned end panels in a spacious vaulted glass ceiling up 2.75m wide x 8.7m long in size.

## Skypod SQ

The alternative to a single span rectangular rooflight, Skypod SQ is the square lantern roof that offers perfectly balanced sightlines and, thanks to its simple 4-hip design, higher levels of natural light than conventional designs of the same surface area. Because Skypod SQ can be produced in sizes right down to 0.5m x 0.5m, it means even the smallest flat roofed space in the home can benefit from day long natural light.



With this 3-bar gable design, you can create larger lantern roofs

## skypod<sup>SQ</sup>

Now you can give your customers a square lantern roof – with symmetrical looks!



THERMALLY BROKEN  
RIDGE

1.0\*  
U-VALUE

THERMALLY BROKEN  
RING BEAM

NEW

SLEEK  
DESIGN

ARCHITECTURAL  
COLOURS

skypod®

EXCEPTIONAL STYLE & PERFORMANCE

### New and improved

The Eurocell Skypod pitched lantern roof system has had further enhancements with the introduction of a more discreet internal boss, purpose designed and secure fix external rafter end caps and a thermally broken ring beam to create a virtually condensation free finish.

### Colours to frame the view

Like all Eurocell PVC-U products, Skypod comes with an exact colour-match guarantee. That means the colour is precisely matched to all Eurocell window, door and conservatory roof products, creating a co-ordinated, consistent look across any property.

Skypod has a white internal finish as standard, to maintain a bright, fresh interior. A range of external colours is available to complement existing architectural style, as well as a choice of glass options.

### Ten-year guarantee

Skypod lantern roofs are guaranteed for ten years. That means you can give your customers the assurance of a robust, well-designed, precision-made product that's built to last – manufactured by the UK's leading PVC-U specialist.

# UNIQUE

## SPIDER BAR GLAZING CAP



PURPOSE DESIGNED  
RAFTER END CAPS

**NEW**

FIXED **20°**  
OR  
**35°** PITCH

### FRAME COLOURS



**WHITE**  
White interior

**ANTHRACITE GREY**  
White interior

**ANTHRACITE GREY\***  
Anthracite interior

**MOONDUST GREY**  
White interior

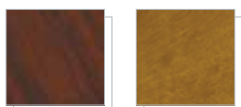

**ROSEWOOD**  
White interior

**GOLDEN OAK**  
White interior

### GLASS COLOURS



**BLUE**      **NEUTRAL**      **BRONZE**



**AQUA**      **CLEAR**

ADDITIONAL COLOURS AND SPECIFICATIONS ARE MADE TO ORDER ON EXTENDED LEAD TIMES

\* Anthracite Grey/Anthracite Grey not available for Skypod Acute





**skypod**<sup>ACUTE</sup>

EXCEPTIONAL STYLE & PERFORMANCE

**skypod**<sup>ACUTE</sup>

**A new angle on the lantern roof**

Homeowners love Skypod lantern roofs for all the extra light and space they bring into the home.

Great if they've got a flat roof big enough to take a full lantern. But what about all those people with smaller extensions and outhouses crying out for a little natural light?

Well, now you can give them exactly what they want with Skypod Acute.

**35°**  
**skypod**<sup>ACUTE</sup>

**35°**  
**skypod**<sup>SQ</sup>  
ACUTE



## Pitch for more projects

Skypod Acute is a new Skypod design, with a 35° pitch instead of the usual 20°. That means it can be fabricated in much smaller sizes (right down to 0.5m x 0.5m) and fitted to a much smaller roof without losing out on light levels.

## The quick, easy, quality fix

Just like the rest of the Skypod range, Skypod Acute is designed with installers in mind.

Everything you need is right there in the pack, right down to the last support stud and sealing plate. Even the screw holes are predrilled for a quick installation that's right first time, every time.

## More colours to co-ordinate

If you're fitting windows and doors in one of the thirty or more alternatives to plain white available from Eurocell, you'll be glad to hear Skypod Acute can be ordered to match every one of them.

Together, they'll make any home look fantastic from the kerbside. And make you look even better in the eyes of your customers.

For more information and technical advice on Skypod Acute, call our friendly Customer Service Team on **0800 988 3047**.



All available in 20° or 35° fixed pitch

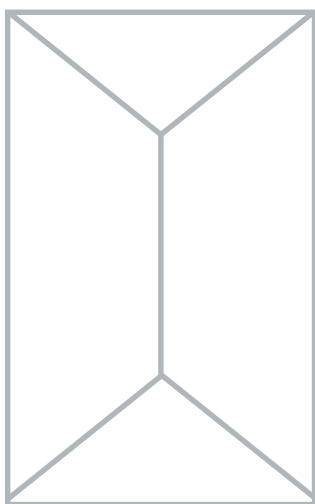

No 'side-bars' needed on sizes up to 1.5m x 2.75m

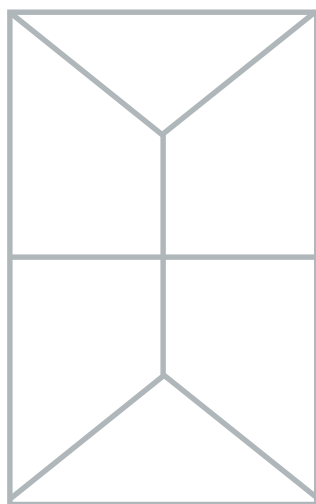

Up to 1.5m x 7.45m

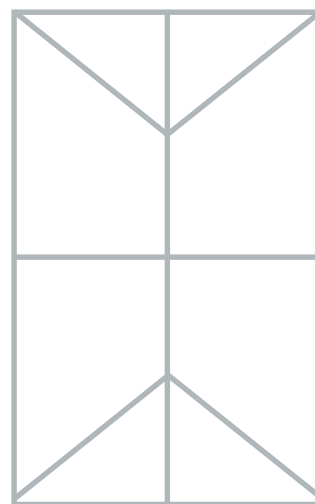

Up to 2.75m x 8.7m

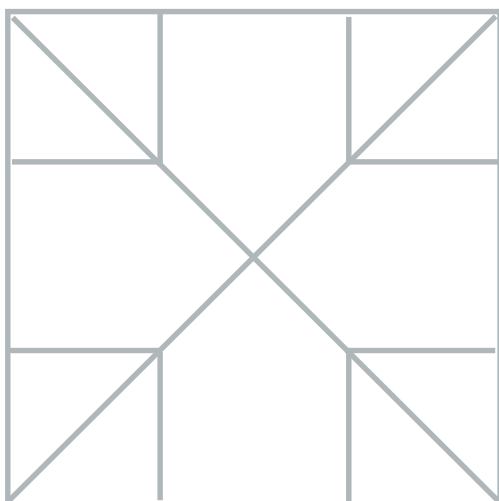

**skypod<sup>SQ</sup>**  
Up to 2.75m x 2.75m

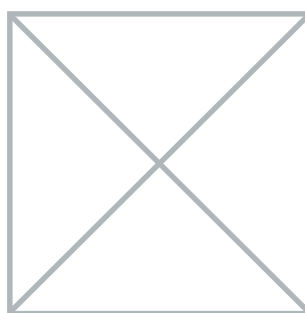

**skypod<sup>SQ</sup>**  
Up to 1.5m x 1.5m



**skypod<sup>ACUTE</sup>**

**Note:** Design will vary dependent on size. All Skypod lantern roofs are made-to-order, and you will receive a design to sign-off before the item goes into production.



## ASSEMBLIES

### Ridge assembly

Powder-coated aluminium, thermally broken

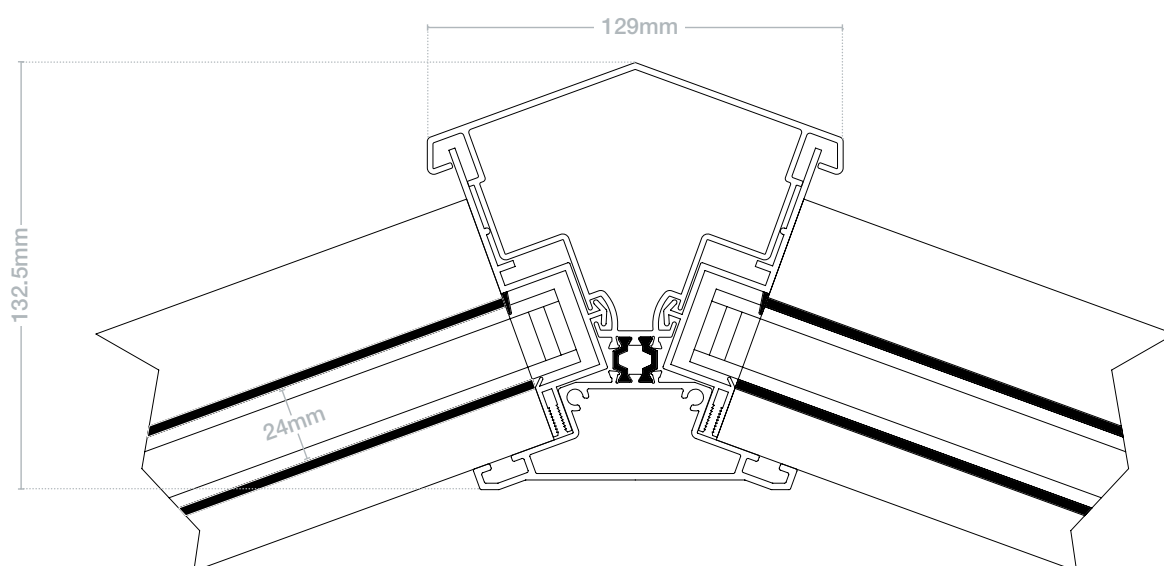

### Rafter assembly

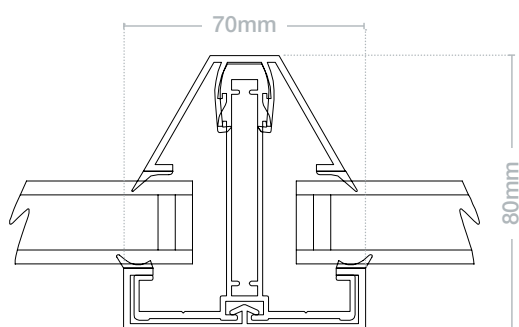

### Hip assembly

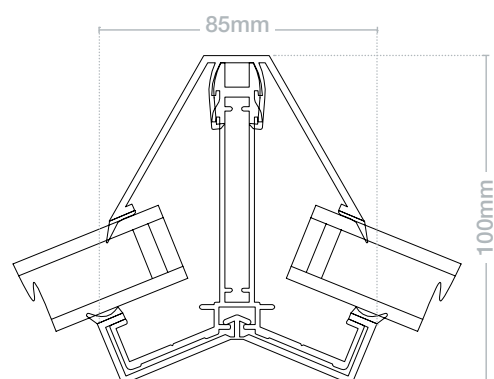

## INSTALLATION

To see an in-depth installation guide, please contact the Customer Care Team on **0333 988 3047**

# TECHNICAL INFORMATION

## SKYPOD PITCHED LANTERN ROOFS

### COMPONENTS

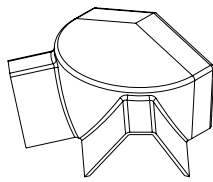

**CRS 9241**  
skypod  
2-bar top cap

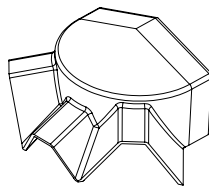

**CRS 9240**  
skypod  
3-bar top cap

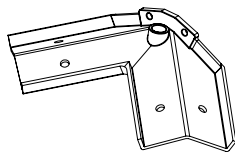

**CRS 9522A**  
skypod  
2-bar spider bracket

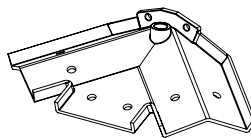

**CRS 9521A**  
skypod  
3-bar spider bracket

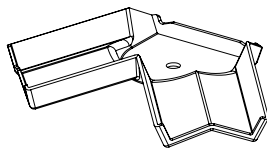

**CRS 9249**  
skypod  
2-bar bottom cap

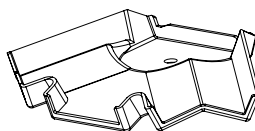

**CRS 9248**  
skypod  
3-bar bottom cap

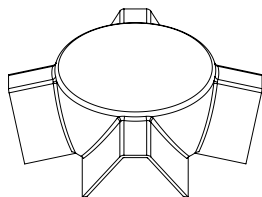

**CRS 9242**  
skypod<sup>SQ</sup>  
Top cap

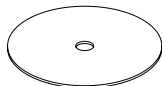

**CRS 9423**  
skypod<sup>SQ</sup>  
Foam bung sealing plate

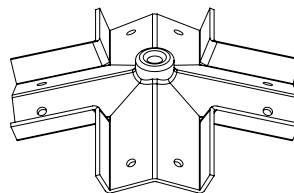

**CRS 9523A**  
skypod<sup>SQ</sup>  
Spider bracket

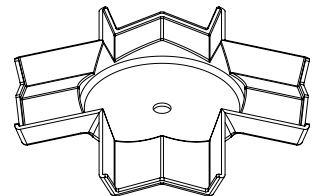

**CRS 9250**  
skypod<sup>SQ</sup>  
Bottom cap

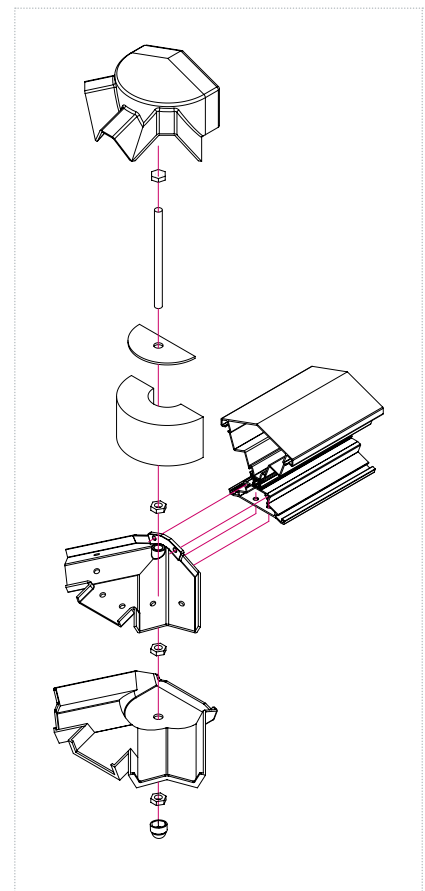



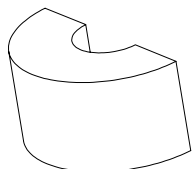

**CRS 9421**  
skypod  
Foam bung



**CRS 9422A**  
skypod  
Foam bung sealing plate

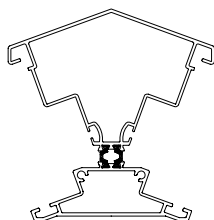

**CRS 9520A**  
skypod  
ridge body



**CRS 8625**  
Single variable  
support stud

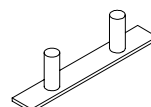

**CRS 8624**  
Double variable  
support stud



NEW

**CRS 9200**  
skypod  
screw cap covers

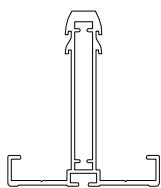

**CRS 8501A**  
Standard rafter

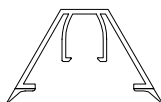

**CRS 8016**  
25mm  
rafter top cap

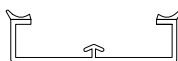

**CRS 8011**  
Rafter bottom cap

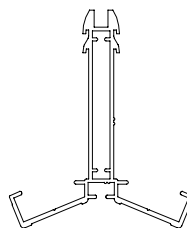

**CRS 8502A**  
Edwardian hip

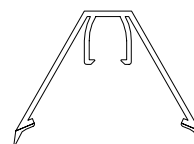

**CRS 8017**  
25mm Edwardian  
hip top cap



**CRS 8053**  
Eaves beam seal

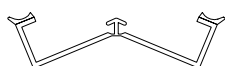

**CRS 8012**  
Hip bottom cap



**CRS 9550A**  
skypod  
Eaves 20°

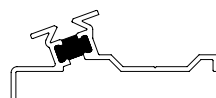

NEW

**CRS 9552A**  
skypod  
Thermally broken eaves beam

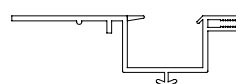

**CRS 8024**  
24/25mm ridge  
glazing trim

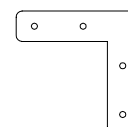

**CRS 8654**  
90° eaves  
beam cleat

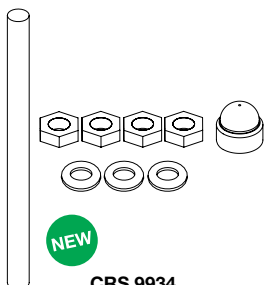

NEW

**CRS 9934**  
skypod  
Boss kit

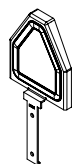

**CRS 8201**  
Rafter / hip end cap

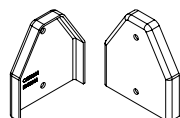

NEW

**CRS 9201**  
skypod  
Rafter end cap

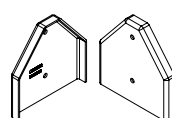

NEW

**CRS 9202**  
skypod  
Hip rafter end cap

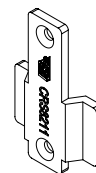

**CRS 8211**  
Glazing stop  
(CRS 8682 Glazing  
stop screws)

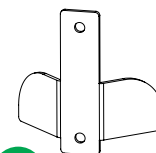

NEW

**CRS 9611S**  
Stainless steel glazing stop  
(CRS 8682 Glazing  
stop screws)

# TECHNICAL INFORMATION

## skypod<sup>ACUTE</sup> PITCHED LANTERN ROOFS

### COMPONENTS

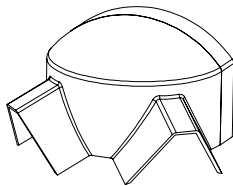

**CRS 9244**  
skypod<sup>ACUTE</sup>  
2 bar top cap

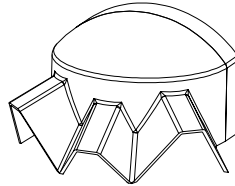

**CRS 9243**  
skypod<sup>ACUTE</sup>  
3 bar top cap

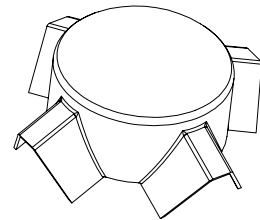

**CRS 9245**  
skypod<sup>ACUTE</sup>  
Gazebo top Cap

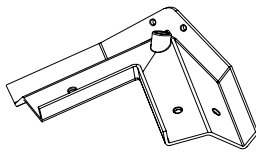

**CRS 9525A**  
skypod<sup>ACUTE</sup>  
2 bar spider bracket

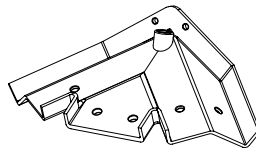

**CRS 9524A**  
skypod<sup>ACUTE</sup>  
3 bar spider bracket

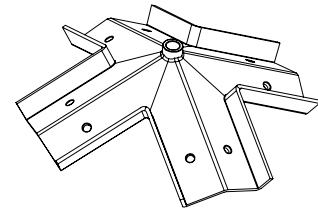

**CRS 9526A**  
skypod<sup>ACUTE</sup>  
Gazebo spider bracket

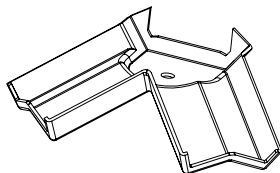

**CRS 9252**  
skypod<sup>ACUTE</sup>  
2 bar bottom cap

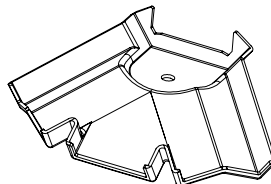

**CRS 9251**  
skypod<sup>ACUTE</sup>  
3 bar bottom cap

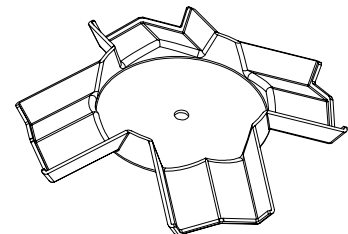

**CR 9253**  
skypod<sup>ACUTE</sup>  
Gazebo bottom Cap

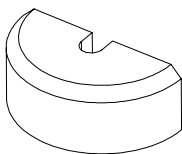

**CR 9424**  
skypod<sup>ACUTE</sup>  
Foam bung

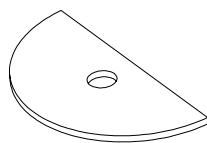

**CRS 9425A**  
skypod<sup>ACUTE</sup>  
Foam bung sealing plate

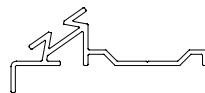

**CRS 9551A**  
skypod<sup>ACUTE</sup>  
Acute Ring Beam

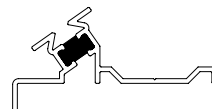

**CRS 9553A**  
skypod<sup>ACUTE</sup>  
Thermally broken ring beam

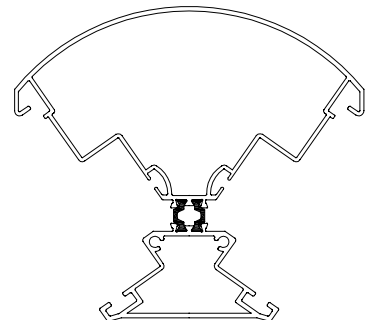

**CRS 9530A**  
skypod<sup>ACUTE</sup>  
Acute ridge body





## CASE STUDY

### SKYPOD TRANSFORMS FLAT-ROOF EXTENSION

When builder Colin Clarkson visited his local Eurocell branch in Wakefield to get a price on some roof tiles, he did not expect to end up renovating his new home from top to bottom in products from one single source. Yet now his upgraded bungalow features Eurocell-sourced products throughout – from Tapco composite slate tiles to Skypod lantern roofs, a Dales Collection composite door, PVC-U windows and even the rainwater goods.

The building itself was an early 1960s two-bedroom brick and block bungalow with a conservatory extension and was in a state of disrepair. Colin saw its potential and bought it to convert into a three-bedroom home with pitched dormers and a flat-roofed extension that matched the best of contemporary design and living standards.

“I first went to Eurocell because it was one of the few suppliers of Tapco composite roof slates and they were well priced, yet then when I saw the Skypod lantern roofs I wanted them. I had a conservatory before and knew this would sort the problem of freezing in winter and boiling in summer. And it all grew from there.”

Supplied with a 10-year guarantee, Skypod lantern roofs are swiftly installed and bring the benefits of extra light and height without the penalty in conservatory heating costs as the double-glazed lantern roof has a U-value of 1.0. A wide range of frame and glass options complement any home while self-cleaning, temperature controlled glass keeps maintenance to a minimum. Available in a choice of designs, Skypod can be manufactured to fit any space with sizes up to 2.75m x 8.7m.

“When I saw the Skypod lantern roofs I wanted them. I had a conservatory before and knew this would sort the problem of freezing in winter and boiling in summer.”

**Colin Clarkson**  
**Builder**



*All together better*

For more information about **skypod**® pitched PVC-U lantern roofs from Eurocell, call our customer services team on **0800 988 3047**, or visit **eurocell.co.uk/skypod**

Eurocell plc, Fairbrook House, Clover Nook Road, Alfreton, Derbyshire DE55 4RF



**eurocell.co.uk**